

E67

2MP Indoor Dome with Basic WDR, SLLS, Vari-focal Lens



- 2 Megapixel with 1080p
- Superior Low Light Sensitivity
- Vari-focal Lens with f2.8-12mm / F1.4
- Basic WDR (75 dB)
- 30 fps at 1920 x 1080
- Vandal Resistant (IK09)

PHOTO INDICATION

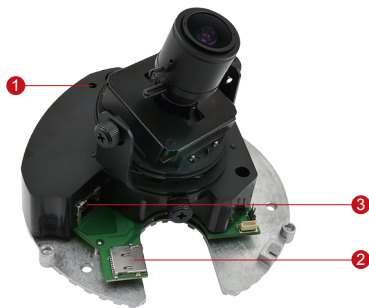

- 1 Reset Button
- 2 Memory Card Slot
- 3 Ethernet Port



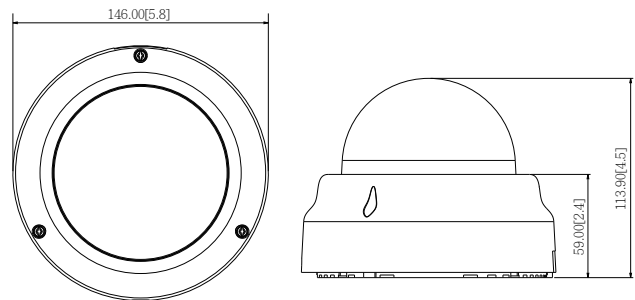



DIMENSION DIAGRAM



Unit: mm [inch]

ACCESSORY OPTIONS

Dome Cover		
PDCX-1101		4-inch, smoked, vandal proof (IK10)

Popular Mounting Solutions		
Surface	Accessories not required	
Wall	PMAX-0308	
Pendant	PMAX-0101 PMAX-0103	
Corner	PMAX-0101 PMAX-0305 PMAX-0402	
Pole	PMAX-0101 PMAX-0305 PMAX-0503	
Flush	PMAX-1003	
Gang Box	PMAX-0803	

* For more mounting solutions, please refer to Project Planner on www.acti.com

PRODUCT SPECIFICATION**E67****• Device**

Device Type	Indoor Dome Camera
Image Sensor	Progressive Scan CMOS
Sensor Size	1/2.8"
Day / Night	No
Superior Low Light Sensitivity	Yes
Minimum Illumination	Color: 0.1 lux at F1.4 (30 IRE, 2400°K)
Mechanical IR Cut Filter	No
IR Sensitivity Range	No
IR LED	No
Electronic Shutter	1/5 ~ 1/2,000 sec (manual mode); 1/5 ~ 1/10,000 sec (auto mode)

• Lens

Focal Length / Aperture	Vari-focal, f2.8 - 12 mm / F1.4
Iris	Fixed iris
Focus	Manual focus
Mount Type	Board mount
Horizontal Viewing Angle	92.5° - 35.9°
Viewing Angle Adjustment	Pan: 0° - 350°; Tilt: 17° - 163°; Rotate: 0° - 350°

• Video

Compression	H.264 HP, MJPEG
Max. Frame Rate vs. Resolution	30 fps at 1920 x 1080; 30 fps at 1280 x 720; 30 fps at 640 x 480; 15 fps at 320 x 240
Multi-Streaming	Simultaneous dual streams based on two configurations
Bit Rate	28 Kbps - 6 Mbps (per stream)
Bit Rate Mode	Constant, Variable
Image Enhancement	Basic WDR (75 dB); White balance: automatic, hold, and manual; Brightness; Contrast; Sharpness (auto); Auto gain control; Digital noise reduction; Flickerless
Privacy Mask	4 configurable regions
Text Overlay	User defined text on video
Image Orientation	Image flip and mirror

• Network

Protocol & Service	TCP, UDP, HTTP, HTTPS, DHCP, PPPoE, RTP, RTSP, IPv6, DNS, DDNS, NTP, ICMP, ARP, IGMP, SMTP, FTP, UPnP, SNMP, Bonjour
Ethernet Port	1, Ethernet (10/100 Base-T), RJ-45 connector
Security	IP address filtering; HTTPs encryption; Password protected user levels; Anonymous login; IEEE802.1X network access control

• Alarm

Alarm Trigger	Video motion detection (3 regions)
Alarm Response	Notify control center; Change camera settings; Command other devices; E-mail notification with snapshots; Save video or snapshot to local storage; Upload video, Snapshot to FTP

• Interface

Local Storage	MicroSDHC/MicroSDXC memory card slot (card not included)
---------------	----------------------------------------------------------

• General

Power Source / Consumption	PoE Class 2 (IEEE802.3af) / 3.7W
Weight	503 g (1.11 lb)
Dimensions (Ø x H)	146 mm x 113.9 mm (5.8" x 4.5")
Environmental Casing	Vandal resistant (IK09 rated); Transparent dome cover
Mount Type	Surface, Pendant, Wall, Corner, Pole, Flush, Gang box
Starting Temperature	-10°C ~ 50°C (14°F ~ 122°F)
Operating Temperature	-10°C ~ 50°C (14°F ~ 122°F)
Operating Humidity	10% ~ 85% RH
Approvals	CE (EN 55022 Class B, EN 55024), FCC (Part15 Subpart B Class B), IK09

• Integration

Unified Solution	Fully compatible with ACTi software
ISV Integration	Software Development Kit (SDK) available; ONVIF compliant
Firmware Access Browser	Microsoft Internet Explorer 8.0 or newer (full functionality) Safari with QuickTime installed, and other browsers with VLC installed (partial functionality)